

Toucan Eco Active install guide

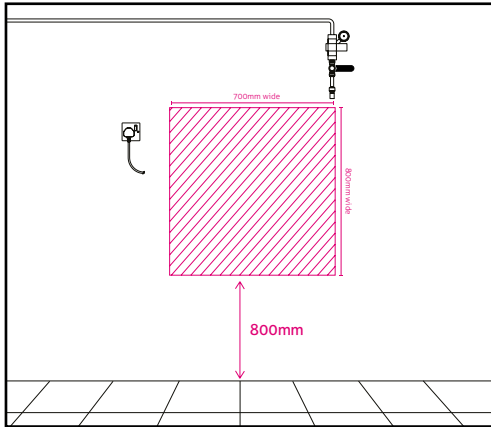

1. Choose a wall area 700mm wide and 800mm high that is 800mm above floor level and near to a socket and water supply.

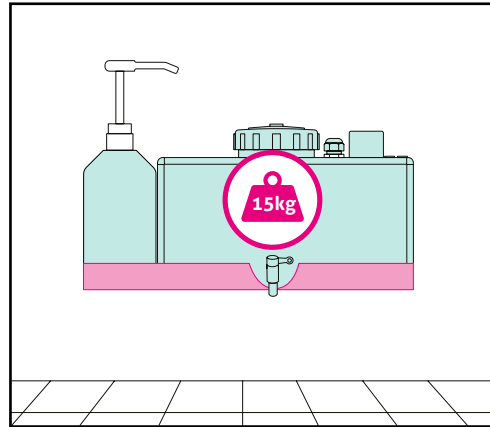

2. Fix the shelf to the wall 800mm above the floor, making sure it can take 15kg, and near to a 15mm water pipe and power socket.

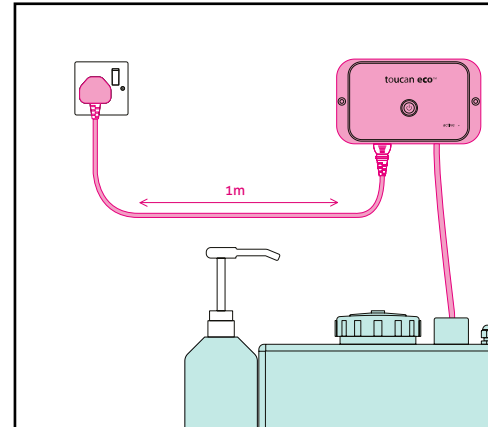

3. Fit the control box to the wall within 1m of the plug socket, and connect the power lead from the control box to the power socket.

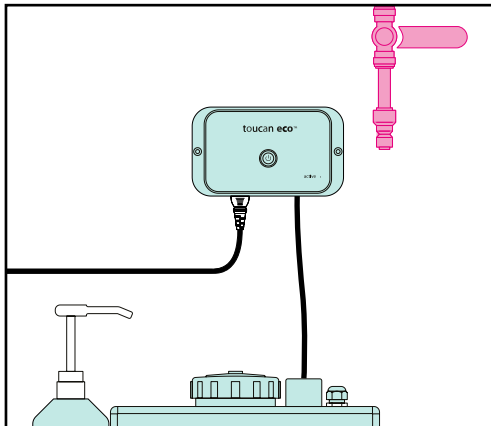

4. Fit the 15mm spur and ball lever valve (not supplied). Then fit the 15mm to 10mm reducer.

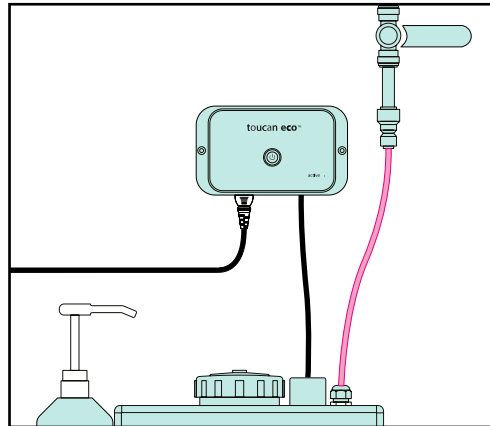

5. And fit the 10mm pipe from the reducer into the top of the tank through the gland.

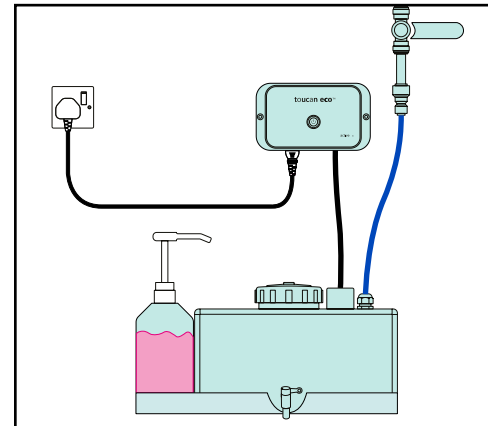

6. Add the granulated salt into the brine container and fill with water. The unit is now ready to operate.

Components

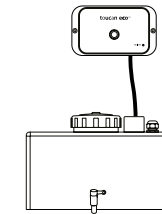

10L holding tank and control box with tap and 3/4" backnut.

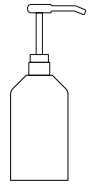

2.5L brine container and dispenser.

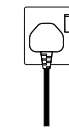

Control box power lead

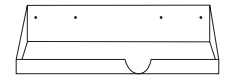

Stainless steel shelf.



15mm to 10mm reducer.



10mm blue feeder pipe.

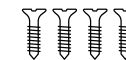

4x shelf screws and wall plugs.

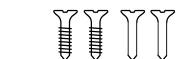

2x control box screw and wall plugs